



## INDUSTRIAL Pressure Transducer AST2000

### Overview

The AST2000 is an ASIC-compensated, high quality, stainless steel industrial pressure transducer designed for use in the measurement of liquids and gases. Intended for mid to high volume applications requiring excellent performance, the AST2000 succeeds by offering highly competitive pricing.

### Benefits

- Fully Welded Stainless Steel Housing
- No Oil Fill, Welds, or Internal O-rings
- Wide Operating Temperature
- Compatible with Liquids and Gases
- Rugged, Compact Design
- Pressures up to 10,000 PSI
- High Shock and Vibration
- EMI/RFI Protection

### Applications

- Industrial OEM Equipment
- Hydraulic Systems
- HVAC Equipment
- Refrigeration Equipment
- Automotive
- Energy / Water Management
- Test Stands
- Off-Road / Construction Equipment
- Railways (Braking, Compressor & Engine Controls)

**Environmental Data****Ambient Temperature: 25°C (77°F) (Unless otherwise specified)**

<b>Operating Ambient</b>	-40 to 125°C (-40 to 250°F)
<b>Storage</b>	-40 to 125°C (-40 to 250°F)

**Electromagnetic Compatibility (EMC)**

<b>Standard</b>	<b>Description</b>	<b>Test Value</b>
EN55011	Radiated Emissions	Class A, 30-1000 MHz
EN61000-4-2	Electrostatic Discharge Immunity	±8 kV Air Discharge ±4 kV Contact Discharge, VCP, HCP
EN61000-4-3	Radiated Electromagnetic Field Immunity	10V/m, 80-2700 MHz 80% 1kHz AM Modulation
EN61000-4-4	Electrical Fast Transient/Burst Immunity	±0.5 kV, ±1 kV, ±2 kV on DC Mains ±0.5 kV, ±1 kV on I/O Ports
EN61000-4-5	Surge Immunity	±0.5 kV, ±1 kV, on I/O Ports & DC Lines
EN61000-4-6	Conducted immunity	10V rms, 0.15-80 MHz, DC Mains 10V rms, 0.15-80 MHz, I/O Ports 80% 1kHz AM Modulation
EN61000-4-8	Power Frequency Magnetic Field Immunity Test	30 A/m @ (50Hz, 60Hz) 3 orthogonal orientations

**Shock, Vibration & Ingress Protection (IP)**

<b>Standard</b>	<b>Description</b>	<b>Test Value</b>
EN 60067-2-27	Shock Test	500m/s <sup>2</sup> , 6ms, half sine-wave, 6 shocks (3/direction), horizontal and vertical axis, 12 total shocks
EN 60068-2-6	Sinusoidal Vibration	5-25 Hz, 2mm, 25-150 Hz, 50m/s, Sweep rate: 1 octave/min, Duration: 24 hours/axis (48 hours total), horizontal and vertical axis
EN 60068-2-64	Random Vibration	10-2000 Hz, vibration level: 0.0314 (m/s <sup>2</sup> ) <sup>2</sup> /Hz, 24 hrs/axis (48 hrs total), 2 directions: horizontal and vertical
IEC 60068-2-32	Drop Test	Drop of 1 meter to floor made of concrete. Dropped twice on the threaded end and two times perpendicular to the threaded end.
IP-66	Ingress Protection	Dust-tight, protected against powerful water jets

**Performance**

**Ambient Temperature: 25°C (77°F) (Unless otherwise specified)**

Parameters	MIN	TYP	MAX	UNITS	NOTES
Accuracy	-0.25		+0.25	%Span	1
Zero Error	-0.5		+0.5	%Span	2
Zero Error (4-20mA)	-1.0		+1.0	%Span	2
Span Error	-1.0		+1.0	%Span	3
Thermal Error, Zero	-1.0		+1.0	%Span	4
Thermal Error, Span	-1.0		+1.0	%Span	5
Stability (1 year)		±0.25		%Span	
Proof Pressure		2X Rated Pressure		PSI	6
Burst Pressure		5X Rated Pressure or 20,000 (whichever is less)		PSI	7
Compensated Temp. Range		0 - 55° (32 to 132°)		°C (°F)	

**Electrical Data**

Model	AST2000		
Output	4-20mA	1-5V, 1-6V	0.5-4.5V Ratiometric
Excitation	10-28VDC	10-28VDC	5.0 ± 0.5VDC
Output Impedance	<10k Ω	< 100 Ω	< 100 Ω
Current Consumption	-	<10mA	<10mA
Output Noise	-	<2mV RMS	<2mV RMS
Output Load	0-800Ω	10k Ω Min.	10k Ω Min.
Reverse Polarity Protection	Yes	Yes	Yes
Bandwidth	DC-250 Hz	DC-1kHz	DC-1kHz

**Notes**

1. The maximum deviation from a best fit straight line (BFSL) fitted to the output measured over the pressure range at 25°C. Includes all errors due to pressure non-linearity, hysteresis, and non-repeatability. Span is the algebraic difference between full scale output and zero pressure offset.
2. The maximum variation from the ideal offset measured at 25°C.
3. The maximum variation from the ideal full-scale span measured at 25°C.
4. The maximum variation of offset within the compensated temperature range relative to 25°C.
5. The maximum variation of full-scale span within the compensated temperature range relative to 25°C.
6. The maximum pressure that can be safely applied to the product for it to remain in specification once pressure is returned to the operating pressure range.
7. The maximum pressure that can be applied without causing escape of the pressure media.

**Dimensions & Electrical Connection**

Unless otherwise specified, all dimensions are in inches

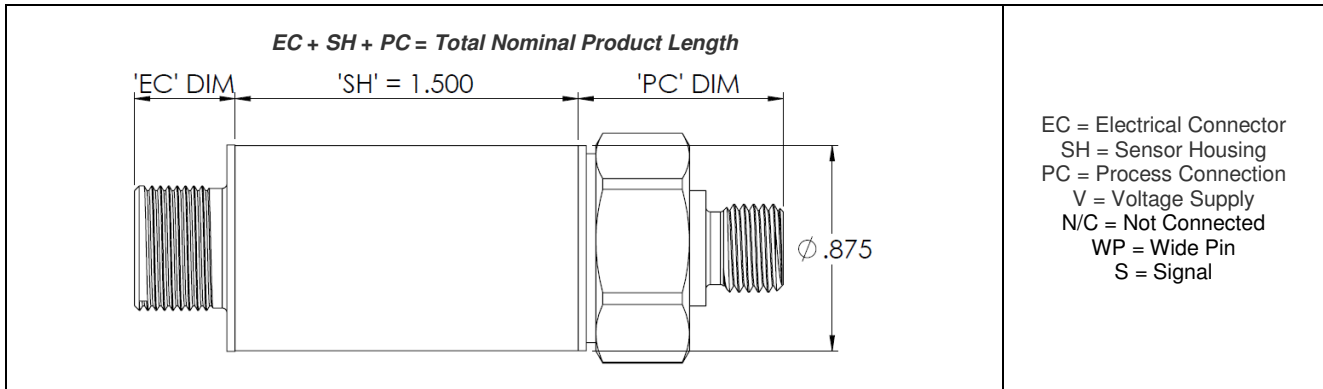

EC = Electrical Connector  
 SH = Sensor Housing  
 PC = Process Connection  
 V = Voltage Supply  
 N/C = Not Connected  
 WP = Wide Pin  
 S = Signal

**Electrical Connectors Option Codes**

Electrical Connectors Option Codes																																																															
<b>E</b> DIN 43650C 8.0mm (Mini-DIN)	<b>F</b> Packard Metripack, 150	<b>K</b> Deutsch, DT04-3P	<b>R</b> 6 Pin Bendix																																																												
<table border="1" style="margin: auto;"> <thead> <tr> <th>Pin</th> <th>3 Wire Voltage</th> <th>4-20mA</th> </tr> </thead> <tbody> <tr> <td>1</td> <td>S</td> <td>N/C</td> </tr> <tr> <td>2</td> <td>GND</td> <td>-V</td> </tr> <tr> <td>3</td> <td>+V</td> <td>+V</td> </tr> <tr> <td>WP</td> <td>N/C</td> <td>N/C</td> </tr> </tbody> </table>	Pin	3 Wire Voltage	4-20mA	1	S	N/C	2	GND	-V	3	+V	+V	WP	N/C	N/C	<table border="1" style="margin: auto;"> <thead> <tr> <th>Pin</th> <th>3 Wire Voltage</th> <th>4-20mA</th> </tr> </thead> <tbody> <tr> <td>A</td> <td>GND</td> <td>-V</td> </tr> <tr> <td>B</td> <td>+V</td> <td>+V</td> </tr> <tr> <td>C</td> <td>S</td> <td>N/C</td> </tr> </tbody> </table>	Pin	3 Wire Voltage	4-20mA	A	GND	-V	B	+V	+V	C	S	N/C	<table border="1" style="margin: auto;"> <thead> <tr> <th>Pin</th> <th>3 Wire Voltage</th> <th>4-20mA</th> </tr> </thead> <tbody> <tr> <td>A</td> <td>+V</td> <td>+V</td> </tr> <tr> <td>B</td> <td>GND</td> <td>-V</td> </tr> <tr> <td>C</td> <td>S</td> <td>N/C</td> </tr> </tbody> </table>	Pin	3 Wire Voltage	4-20mA	A	+V	+V	B	GND	-V	C	S	N/C	<table border="1" style="margin: auto;"> <thead> <tr> <th>Pin</th> <th>3 Wire Voltage</th> <th>4-20mA</th> </tr> </thead> <tbody> <tr> <td>A</td> <td>+V</td> <td>+V</td> </tr> <tr> <td>B</td> <td>S</td> <td>-V</td> </tr> <tr> <td>C</td> <td>N/C</td> <td>N/C</td> </tr> <tr> <td>D</td> <td>GND</td> <td>N/C</td> </tr> <tr> <td>E</td> <td>N/C</td> <td>N/C</td> </tr> <tr> <td>F</td> <td>N/C</td> <td>N/C</td> </tr> </tbody> </table>	Pin	3 Wire Voltage	4-20mA	A	+V	+V	B	S	-V	C	N/C	N/C	D	GND	N/C	E	N/C	N/C	F	N/C	N/C
Pin	3 Wire Voltage	4-20mA																																																													
1	S	N/C																																																													
2	GND	-V																																																													
3	+V	+V																																																													
WP	N/C	N/C																																																													
Pin	3 Wire Voltage	4-20mA																																																													
A	GND	-V																																																													
B	+V	+V																																																													
C	S	N/C																																																													
Pin	3 Wire Voltage	4-20mA																																																													
A	+V	+V																																																													
B	GND	-V																																																													
C	S	N/C																																																													
Pin	3 Wire Voltage	4-20mA																																																													
A	+V	+V																																																													
B	S	-V																																																													
C	N/C	N/C																																																													
D	GND	N/C																																																													
E	N/C	N/C																																																													
F	N/C	N/C																																																													

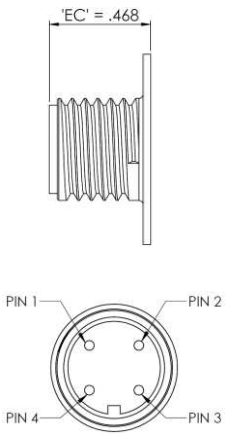
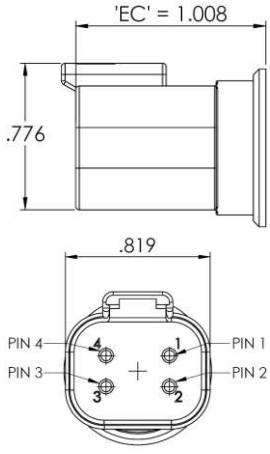
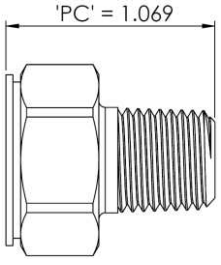
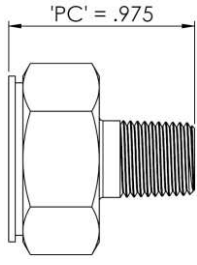
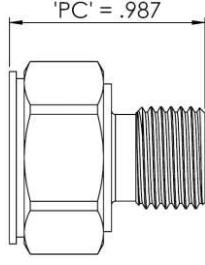
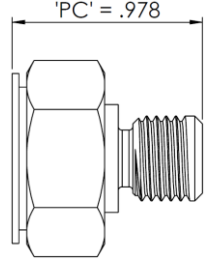
Electrical Connectors Option Codes (Cont'd)																																	
Y M12X1		Z Deutsch, DT04-4P																															
																																	
<table border="1" data-bbox="341 829 630 945"> <thead> <tr> <th>Pin</th> <th>3 Wire Voltage</th> <th>4-20mA</th> </tr> </thead> <tbody> <tr> <td>1</td> <td>+V</td> <td>+V</td> </tr> <tr> <td>2</td> <td>N/C</td> <td>N/C</td> </tr> <tr> <td>3</td> <td>GND</td> <td>-V</td> </tr> <tr> <td>4</td> <td>S</td> <td>N/C</td> </tr> </tbody> </table>		Pin	3 Wire Voltage	4-20mA	1	+V	+V	2	N/C	N/C	3	GND	-V	4	S	N/C	<table border="1" data-bbox="990 840 1291 955"> <thead> <tr> <th>Pin</th> <th>3 Wire Voltage</th> <th>4-20mA</th> </tr> </thead> <tbody> <tr> <td>1</td> <td>+V</td> <td>+V</td> </tr> <tr> <td>2</td> <td>GND</td> <td>-V</td> </tr> <tr> <td>3</td> <td>S</td> <td>N/C</td> </tr> <tr> <td>4</td> <td>N/C</td> <td>N/C</td> </tr> </tbody> </table>		Pin	3 Wire Voltage	4-20mA	1	+V	+V	2	GND	-V	3	S	N/C	4	N/C	N/C
Pin	3 Wire Voltage	4-20mA																															
1	+V	+V																															
2	N/C	N/C																															
3	GND	-V																															
4	S	N/C																															
Pin	3 Wire Voltage	4-20mA																															
1	+V	+V																															
2	GND	-V																															
3	S	N/C																															
4	N/C	N/C																															
Pressure Port Option Codes																																	
A 1/4 NPT Male	B 1/8 NPT Male	C 1/4 BSPP Male	F 7/16 – 20 UNF Male																														
																																	

Legend	
✓	Standard Available
X	Not Available

**Available Process Connection, Material Configurations & Pressure Codes**

**17-4PH PSI**

Pressure Range	Pressure Range Code	PSI Unit	Process Connection Code			
			A	B	C	F
-14.7 - 25	V0025	P	✓	X	✓	X
-14.7 - 50	V0050	P	✓	✓	✓	✓
-14.7 - 100	V0100	P	✓	✓	✓	✓
-14.7 - 150	V0150	P	✓	✓	✓	✓
-14.7 - 200	V0200	P	✓	✓	✓	✓
-14.7 - 250	V0250	P	✓	✓	✓	✓
-14.7 - 500	V0500	P	✓	✓	✓	✓
0 - 25	00025	P	✓	X	✓	X
0 - 50	00050	P	✓	✓	✓	✓
0 - 100	00100	P	✓	✓	✓	✓
0 - 150	00150	P	✓	✓	✓	✓
0 - 200	00200	P	✓	✓	✓	✓
0 - 250	00250	P	✓	✓	✓	✓
0 - 500	00500	P	✓	✓	✓	✓
0 - 1,000	01000	P	✓	✓	✓	✓
0 - 2,500	02500	P	✓	✓	✓	✓
0 - 5,000	05000	P	✓	✓	✓	✓
0 - 7,500	07500	P	✓	✓	✓	✓
0 - 10,000	10000	P	✓	✓	✓	✓

**17-4PH Bar**

Pressure Range	Pressure Range Code	BAR Unit	Process Connection Code			
			A	B	C	F
-1 to 2	V0002	B	✓	✓	✓	✓
-1 to 5	V0005	B	✓	✓	✓	✓
-1 to 7	V0007	B	✓	✓	✓	✓
-1 to 10	V0010	B	✓	✓	✓	✓
-1 to 20	V0020	B	✓	✓	✓	✓
0 - 2	00002	B	✓	✓	✓	✓
0 - 5	00005	B	✓	✓	✓	✓
0 - 7	00007	B	✓	✓	✓	✓
0 - 10	00010	B	✓	✓	✓	✓
0 - 20	00020	B	✓	✓	✓	✓
0 - 35	00035	B	✓	✓	✓	✓
0 - 50	00050	B	✓	✓	✓	✓
0 - 100	00100	B	✓	✓	✓	✓
0 - 250	00250	B	✓	✓	✓	✓
0 - 350	00350	B	✓	✓	✓	✓
0 - 500	00500	B	✓	✓	✓	✓
0 - 700	00700	B	✓	✓	✓	✓

# INDUSTRIAL OEM

AST2000 Pressure Transmitter

## 316L PSI

Pressure Range	Pressure Range Code	PSI Unit	Process Connection Code			
			A	B	C	W
-14.7 - 25	V0025	P	✓	X	✓	X
-14.7 - 50	V0050	P	✓	X	✓	✓
-14.7 - 100	V0100	P	✓	X	✓	✓
-14.7 - 150	V0150	P	✓	X	✓	✓
-14.7 - 200	V0200	P	✓	X	✓	✓
-14.7 - 250	V0250	P	✓	X	✓	✓
-14.7 - 500	V0500	P	✓	X	✓	✓
0 - 25	00025	P	✓	X	✓	X
0 - 50	00050	P	✓	X	✓	✓
0 - 100	00100	P	✓	X	✓	✓
0 - 150	00150	P	✓	X	✓	✓
0 - 200	00200	P	✓	X	✓	✓
0 - 250	00250	P	✓	X	✓	✓
0 - 500	00500	P	✓	X	✓	✓
0 - 1,000	01000	P	✓	X	✓	✓
0 - 2,500	02500	P	✓	X	✓	✓
0 - 5,000	05000	P	✓	X	✓	✓
0 - 7,500	07500	P	✓	X	✓	✓
0 - 10,000	10000	P	✓	X	✓	✓
0 - 15,000	15000	P	✓	X	✓	✓
0 - 20,000	20000	P	✓	X	✓	✓

## 316L Bar

Pressure Range	Pressure Range Code	BAR Unit	Process Connection Code			
			A	B	C	F
-1 to 2	V0002	B	✓	X	✓	✓
-1 to 5	V0005	B	✓	X	✓	✓
-1 to 7	V0007	B	✓	X	✓	✓
-1 to 10	V0010	B	✓	X	✓	✓
-1 to 20	V0020	B	✓	X	✓	✓
0 - 2	00002	B	✓	X	✓	✓
0 - 5	00005	B	✓	X	✓	✓
0 - 7	00007	B	✓	X	✓	✓
0 - 10	00010	B	✓	X	✓	✓
0 - 20	00020	B	✓	X	✓	✓
0 - 35	00035	B	✓	X	✓	✓
0 - 50	00050	B	✓	X	✓	✓
0 - 100	00100	B	✓	X	✓	✓
0 - 250	00250	B	✓	X	✓	✓
0 - 350	00350	B	✓	X	✓	✓
0 - 500	00500	B	✓	X	✓	✓
0 - 700	00700	B	✓	X	✓	✓

\*See Ordering Information for list of options.

## INDUSTRIAL OEM

AST2000 Pressure Transmitter

### Ordering Information

AST2000

A

00500

P

4

E

0

000

#### Process Connection

A= 1/4" NPT Male  
B= 1/8" NPT Male  
C= 1/4" BSP Male  
F= 7/16 - 20 UNF Male

#### Pressure Range

Insert Pressure Range Code (see table for availability)

#### Pressure Unit

B=Bar P=PSI

#### Output

1= 0.5-4.5V ratiometric  
3= 1-5V  
4= 4-20mA (2 wire loop powered)  
6= 1-6V

#### Electrical Connection

E= Mini DIN 43650  
F= Packard Metripack 150 3-Pin  
K= Deutsch DT04-3 Pin  
R= 6- Pin Bendix  
Y= M12x1 Eurofast  
Z= Deutsch DT04-4 Pin

#### Wetted Material

0= 17-4PH 1= 316L

#### Option Codes

000= No Options

### NORTH AMERICA

American Sensor Technologies, Inc. (AST),  
a TE Connectivity Company  
Tel: 800-522-6752  
Email: [customercare.molive@te.com](mailto:customercare.molive@te.com)

### ASIA

Hong Kong Sensor Technologies (HKST),  
a TE Connectivity Company  
Tel: 0400-820-6015  
Email: [customercare.shzn@te.com](mailto:customercare.shzn@te.com)

### TE.com/sensors

Measurement Specialties, Inc., a TE Connectivity company.

Measurement Specialties, TE Connectivity, TE Connectivity (logo) and EVERY CONNECTION COUNTS are trademarks. All other logos, products and/or company names referred to herein might be trademarks of their respective owners.

The information given herein, including drawings, illustrations and schematics which are intended for illustration purposes only, is believed to be reliable. However, TE Connectivity makes no warranties as to its accuracy or completeness and disclaims any liability in connection with its use. TE Connectivity's obligations shall only be as set forth in TE Connectivity's Standard Terms and Conditions of Sale for this product and in no case will TE Connectivity be liable for any incidental, indirect or consequential damages arising out of the sale, resale, use or misuse of the product. Users of TE Connectivity products should make their own evaluation to determine the suitability of each such product for the specific application.